

CADENCE

XENITH XM 64HCi

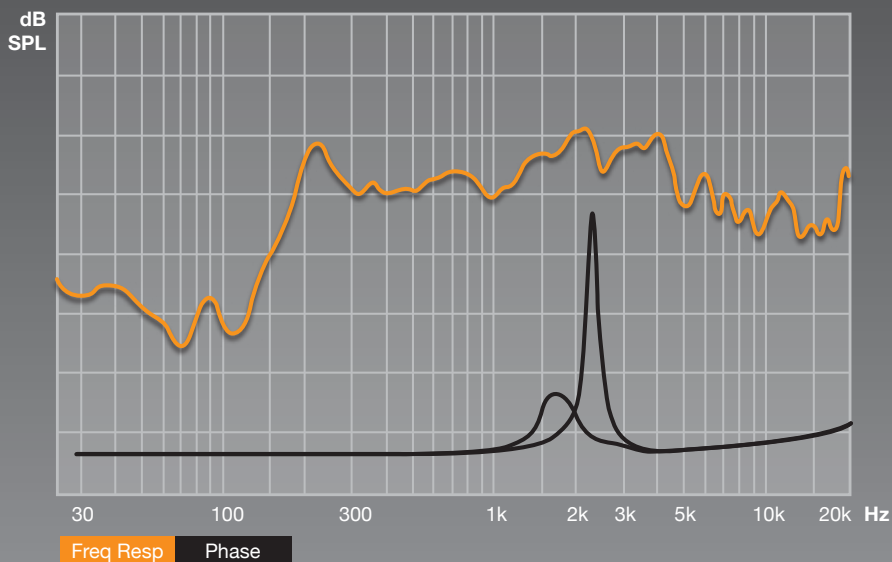

6 in



TS PARAMETERS

FMS: 231.5 Hz **BL:** 4.5
QMS: 10.62 **SPL:** 102 dB
QES: 1.71 **VAS:** 1.6 l
QTS: 1.47 **RE:** 3.4 Ohm
RES: 6.1 Ohm **RP:** 5.3 Ohm
RMS: 1.0 kg/s **LP:** 1.4 mH
CMS: 0.07 mm/N **CP:** 587.9 uF
MMS: 7.1 gr **LE:** 0.2 mH
NREF: 1.15 %

4 Ohm 150 Watts

SPECIFICATIONS

Application: High Compression

Basket Type: Open Basket

Dust Cap: Bullet

Surround Style: Flat Foam

Structure Weight: 60 oz.

Impedance: 4 Ohm

RMS / Peak Watts: 75 / 150

Frequency Response: 150Hz - 15KHz

SPL @ 1w/1m: 102dB

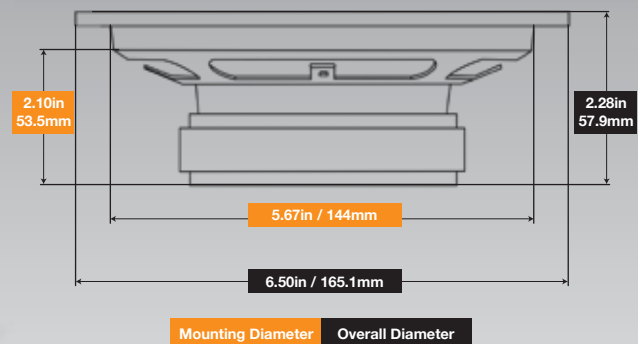

Cadence Acoustics

6519 Highway 9 North • Howell, NJ 07731
800.477.2328 • 732.370.5400 • fax: 732.370.5553 • www.cadencesound.com

