

SOUNDSTREAM®

Owner's Manual and Installation Guide

L1.600D	L2.290
L1.1100D	L2.400
L1.1600D	L4.540
L1.2100D	L4.480
	L5.850



CONGRATULATIONS !

You now own a Lil Wonder 4 Series Amplifier, the product of an uncompromising design and engineering philosophy. We suggest you take a moment to document the information below, which will be helpful in the event of theft or if service is needed. Please retain this manual and your sales receipt for future reference.

SOUNDSTREAM amplifiers are the result of American innovation and the highest quality control standards. When properly installed, they will provide you with many years of listening pleasure. Should your amplifier ever need service or replacement due to theft, Please record your information on the following lines to refer to in the event that you may need it later.

IMPORTANT INFORMATION

Serial# _____

Dealer's Name _____

Date of Purchase _____

Installation Shop _____

Installation Date _____

CAUTION

Extended use of a high powered audio system may result in hearing loss or damage. While Precision**Power** systems are capable of "Concert Level" volumes with incredible accuracy, they are also designed for you to enjoy at more reasonable levels all of the sonic subtleties created by musicians. Please observe all local sound ordinances.

FEATURES

- Class-D + Class-AB Hybrid design, Best combination of strong bass and Hi-Fi performance (for L5.850).
- Compact Size And Tiny Footprint.
- Double Side PCB And SMT Components.
- Full Mosfet Design.
- LPF/HPF/BPF Crossover.
- Adjustable BASSBOOST Frequency And Level (Except L5.850).
- Active X-over Function.
- Heavy-duty Aluminum Alloy Heatsink.
- Overload, Overheat, High/Low Voltage Protection.
- ROHS Compliant.

CONTROL FUNCTIONS

1. SPEAKERS

Connect speakers/subwoofers to these terminals. Be sure to check wire for proper polarity. Never connect the speaker cables to chassis ground.

2. +12 Volt Power

Connect this terminal through a FUSE or CIRCUIT BREAKER to the positive terminal of the vehicle battery or the positive terminal of an isolated audio system battery.

Warning: Always protect this power cable by installing a fuse or circuit breaker of the appropriate size within 18 inches (45cm) of the battery terminal connection.

3. Remote Turn On

This terminal turns on the amplifier when (+)12 volt is applied to it. Connect it to the remote turn on lead of the head unit or signal source.

4. GND

Connect this cable directly to the frame of the vehicle. Make sure the metal frame has been stripped of all paint down to the bare metal. Use the shortest distance possible. It is always a good idea to replace the factory ground at this time with a larger cable equal to the new amplifier power cable or larger. Connecting to the battery is the best ground in the vehicle, but typically not practical to run ground that far.

CONTROL FUNCTIONS

5. RCA input jacks

These RCA input jacks are for use with source units that have RCA outputs. A source unit with a minimum level of 200mV is required for proper operation. The use of high quality twisted pair cables is recommended to decrease the possibility of radiated noise entering the system.

6.High level inputs

The high level inputs are for use with speaker level wiring. Some source units do not have RCA outputs, so use this terminal for speaker level signal input.

CAUTION: Never use high level input when RCA inputs available.

7. Level Control

The level control will match the amplifiers sensitivity to the source units signal voltage. The Operating range is 200mV minimum to 5V maximum. This is NOT a volume control!

8.Low Pass Filter Control

This control is used to select the desired low pass x-over frequency. The frequency can be adjusted from 40Hz to 220Hz for all bass mono models.

9.Subsonic Filter Control

This control can filter out unwanted low frequency from 10Hz (OFF) to 50Hz. This function will increase the power handling of your woofers.

10.Bass Boost Level switch

This switch can boost bass level by 0dB, 6dB or 12dB. The boost frequency is centered at 50Hz.

11. X-over mode and frequency Control (4-ch)

These controls allow control over the frequencies played for the front channels. There is an option for Low Pass, Full Range or High Pass. In LP or HP mode the frequency range is from 50Hz to 4kHz.

12. X-over mode and frequency Control (4-ch)

These controls allow control over the frequencies played for the rear channels. There is an option for Low/BandPass, Full Range or High Pass. In HP mode, the frequency range is from 15Hz to 500Hz. In LP mode, the frequency range can be switched from 50Hz to 800Hz. or 250Hz to 4kHz. In the higher range, the LPF can be set at 4kHz for a middle bass while the front channels are also set at 4kHz for a tweeter resulting in a 2-way x-over and eliminating the need for a passive x-over. Even with a set up like this, the middle bass can still be protected by the HPF which is not defeatable. It

PANEL LAYOUT

Fig 1. L1.600D/L1.1100D/L1.1600D/L1.2100D Panel layout

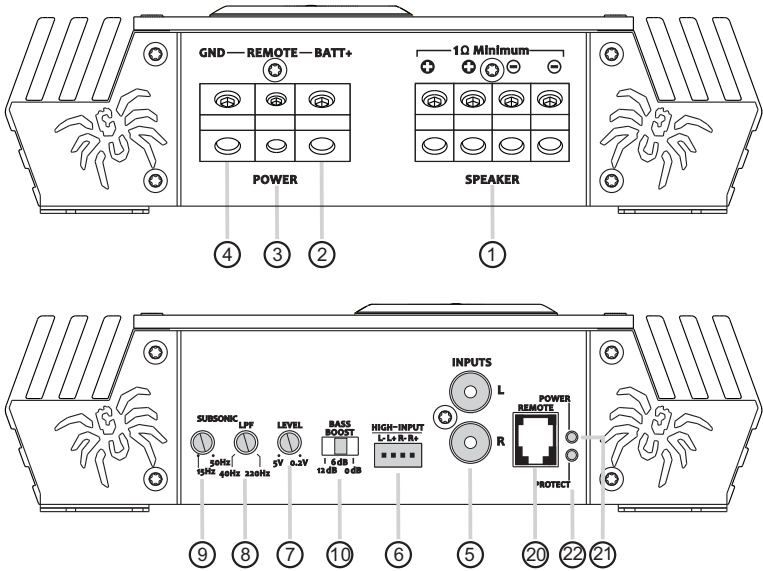
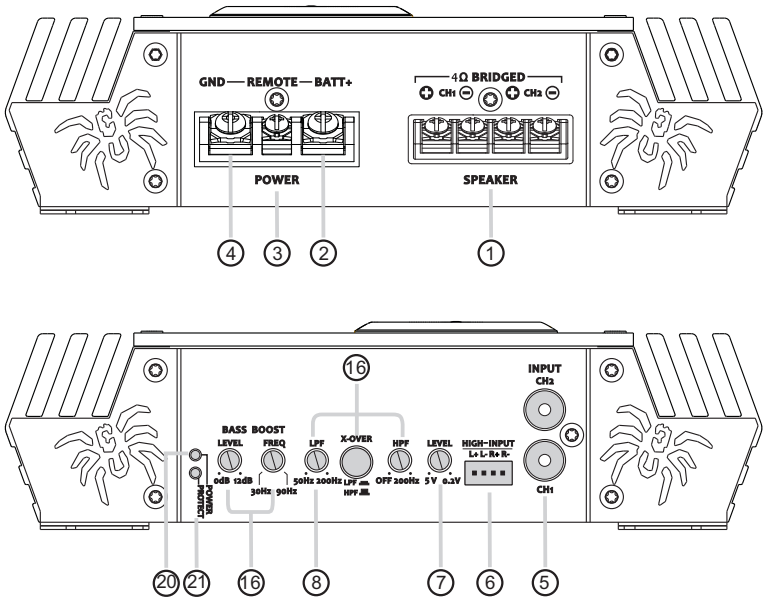

Fig 2. L2.290/L2.400 Panel layout



CONTROL FUNCTIONS

can be set anywhere in the 15Hz to 500Hz range creating a bandpass filter for the middle bass by eliminating any damaging lower frequencies in the sub-bass region.

13. Bass Boost Level switch (4-ch)

This switch can boost bass level by 0dB, 6dB or 12dB. The boost frequency is centered at 50Hz.

14. Input mode switch (4-ch)

This function is for switching the rear channels' signal path. When switched to 4CH, all 4 RCAs inputs are required. When switched to 2CH, the rear channels get their signal input from the front channels in parallel.

15. X-over mode and frequency Control (2-ch)

These controls allow control over the frequencies played for L2.900 & L2.400. There is an option for Low Pass, Full Range or High Pass. In LP mode the frequency range is from 50Hz to 200Hz, In HP mode the frequency range is from 15Hz to 200Hz.

16. Bass Boost Frequency and Level Control (Mono and 2-ch)

By adjusting these two knobs, you can boost a wanted frequency to wanted level. The center boost frequency is adjustable from 30Hz to 90Hz, the boost level is adjustable from 0dB to 12dB.

17. High-Pass-Filter for 4x full frequency channels

This knob adjust the high-pass frequency for 4x full frequency channels. The high pass filter will turn off at the most counterclockwise position, the cutoff frequency will increase when knob turning clockwise till 200Hz.

18. Woofer channel signal selector

The button select the signal source for subwoofer channel. When the button is up, subwofer signal switched to the subwoofer channel's RCA input jack. when the button is down, it mix up 4x full frequency channel's bass signal and pass to subwoofer channel.

19. REMOTE

Connect the remote controller to control the subwoofer amplifier volume from the driver seat location, for ease of adjustment during playing.

20. Power Indicator

This LED will light up when amplifier works properly.

21. Protection Indicator

The red LED will light up if there is a fault presented to the amplifier. Please disconnect the amplifier and resolve the fault before reconnecting the amplifier.

Fig 3. L4.480/L4.540 Panel layout

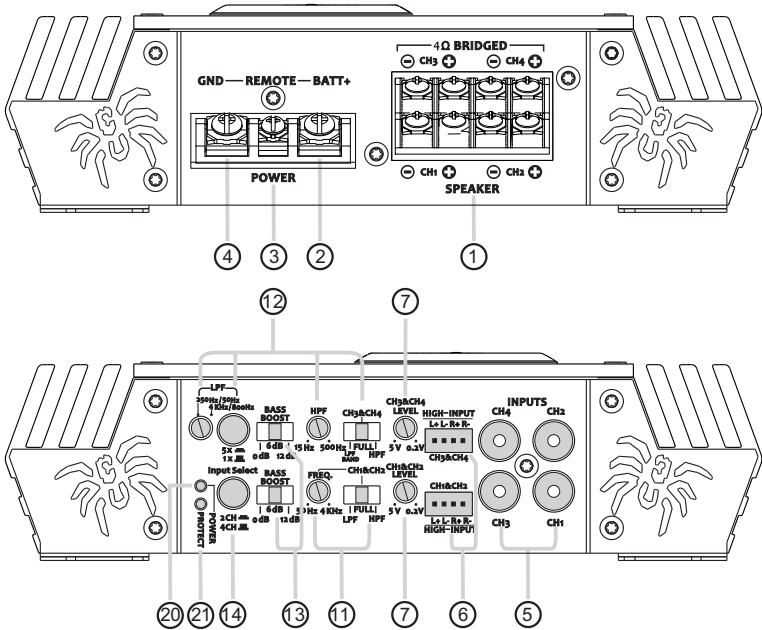
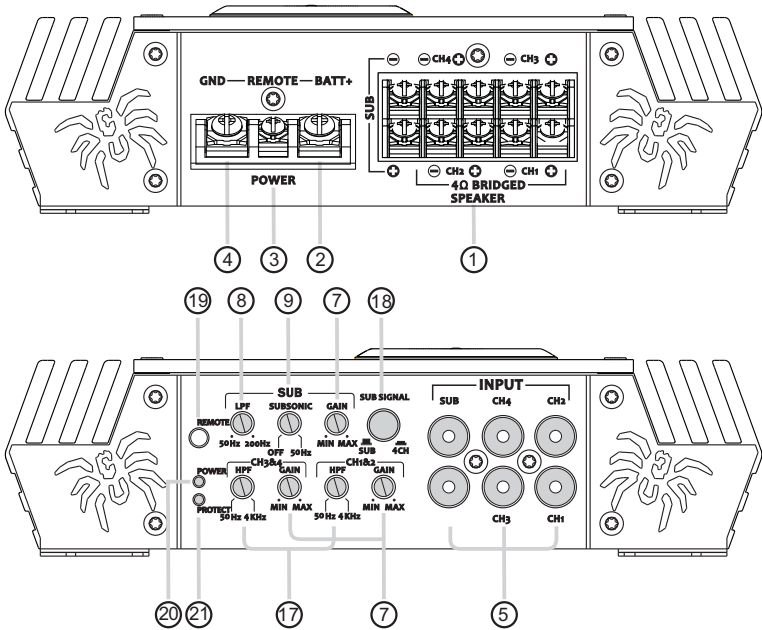

Fig 4. L5.850 Panel layout



INSTALLATION PRECAUTIONS

Before you install the amplifier, investigate your car's layout very carefully. Take special care when you work near the gas tank, fuel lines, hydraulic lines and electrical wiring. Before making or breaking power connections in your system, disconnect the vehicle battery. Confirm that your head unit or other equipment is turned off while connecting the input jacks and speaker terminals. If you need to replace the power fuse, replace it only with a fuse identical to that suggested by this manual. Using a fuse of a different type or rating may result in damage to your audio system or your amplifier which is not covered by warranty .

MOUNTING AMPLIFIER

1. Plan the installation of the amplifiers and find a suitable location with sufficient air circulation.
2. Check the drawing below to mount the bottom amplifier.

Fig 5. Mount amplifier

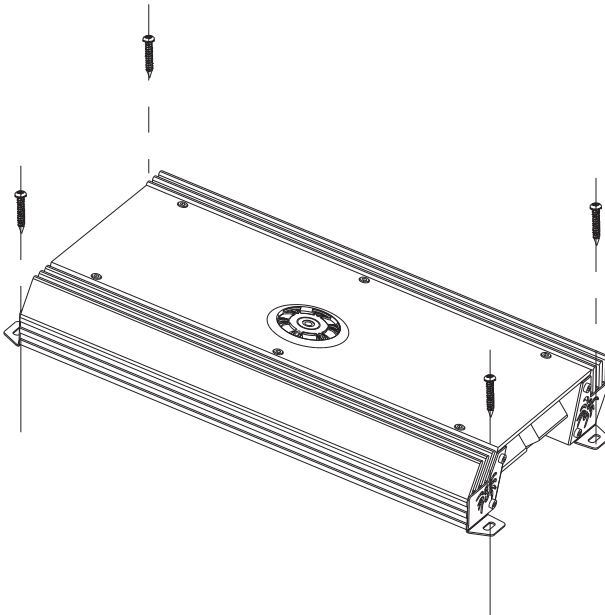

CONNECTING THE AMPLIFIER

1. Select cable and fuse according to the following table.

MODEL	L1.600D	L1.1100D	L1.1600D	L1.2100D	L2.290	L2.400	L4.480	L4.540	L5.850
CABLE	6 #	4 - 6 #	4 #	2 - 4 #	6 #	4 - 6 #	6 #	4 - 6 #	2 - 4 #
FUSE	40 A	100 A	150 A	200 A	60 A	80 A	60 A	80 A	80 A

2. Connect the amplifiers ground with 4 gauge or heavier cable to a close, bare metal part of the frame or chassis. Use a nut and bolt, NOT a screw! The ground cable must be at least the same size as the +12volt cable.

3. Connect the remote terminal to remote output of the head unit using 16 gauge (or heavier) wire.

4. Connect the a 100A fuse holder within 18" (45cm) of the car battery, and run 4 gauge or heavier cable from this fuse to the amplifier.

5. Connect all the inputs with high-quality cables.

6. Insert 100A fuse(s) into the battery fuse holder(s).

Fig 7. Mono amplifier wiring
 (High level input mode)
 L1.600D/L1.1100D/L1.1600D/L1.2100D

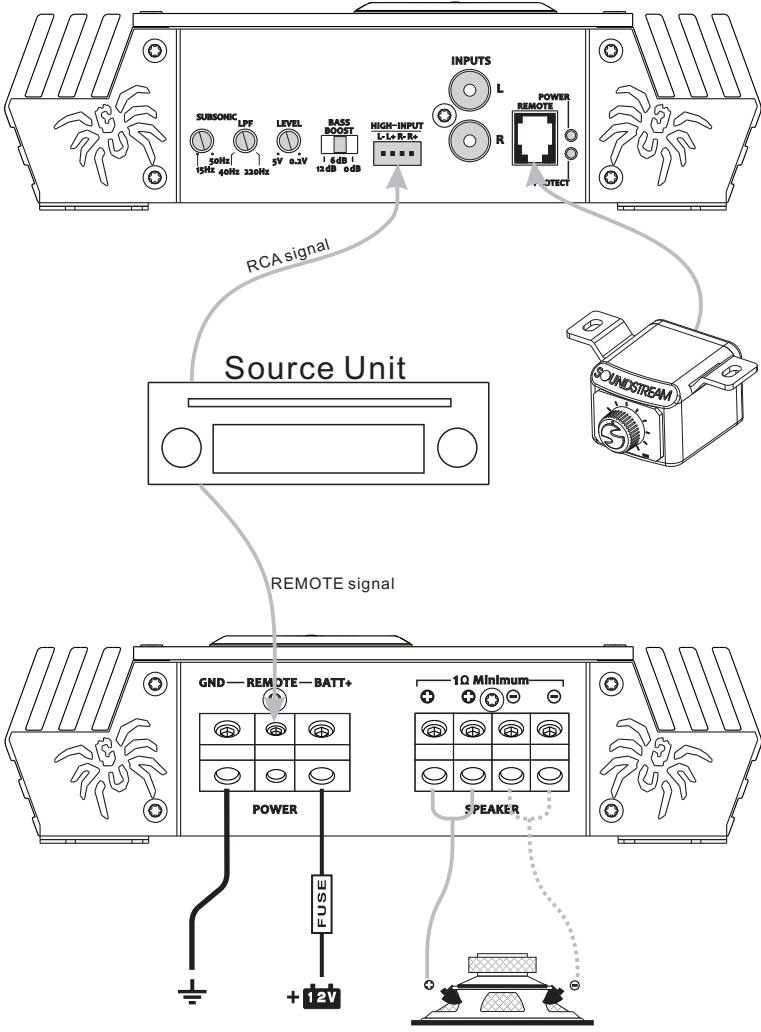

WIRING DIAGRAM

Fig 6. Mono amplifier wiring
(1 woofer load)

L1.600D/L1.1100D/L1.1600D/L1.2100D

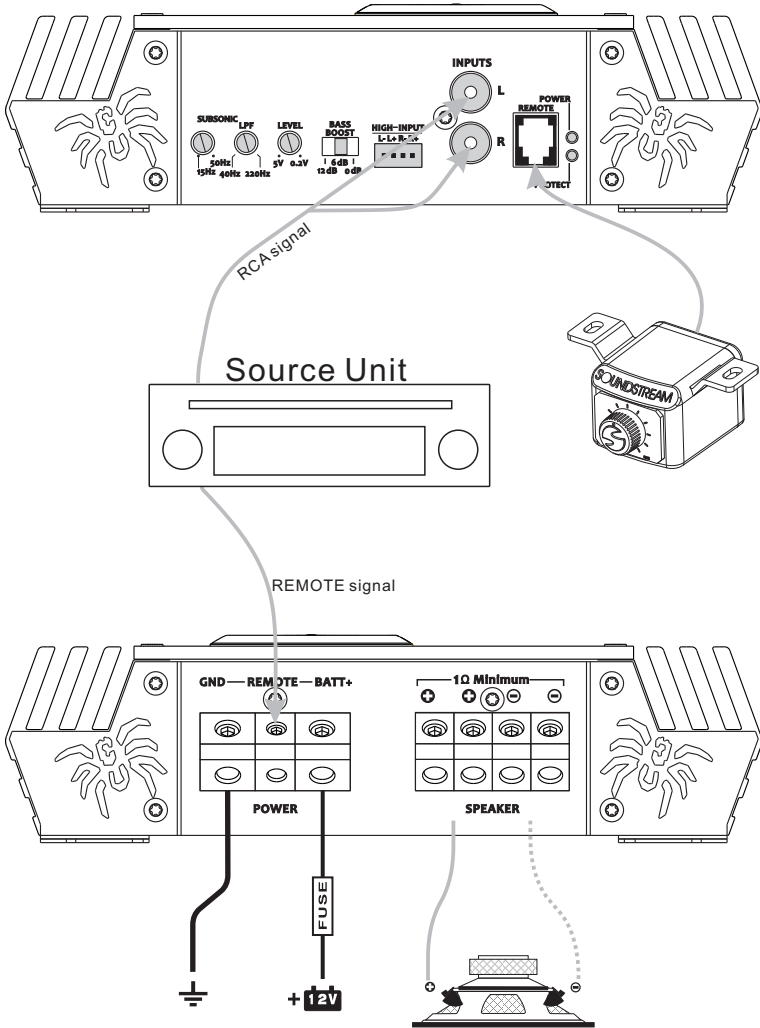

WIRING DIAGRAM

Fig 8. Mono amplifier wiring
(multi woofer)

L1.600D/L1.1100D/L1.1600D/L1.2100D

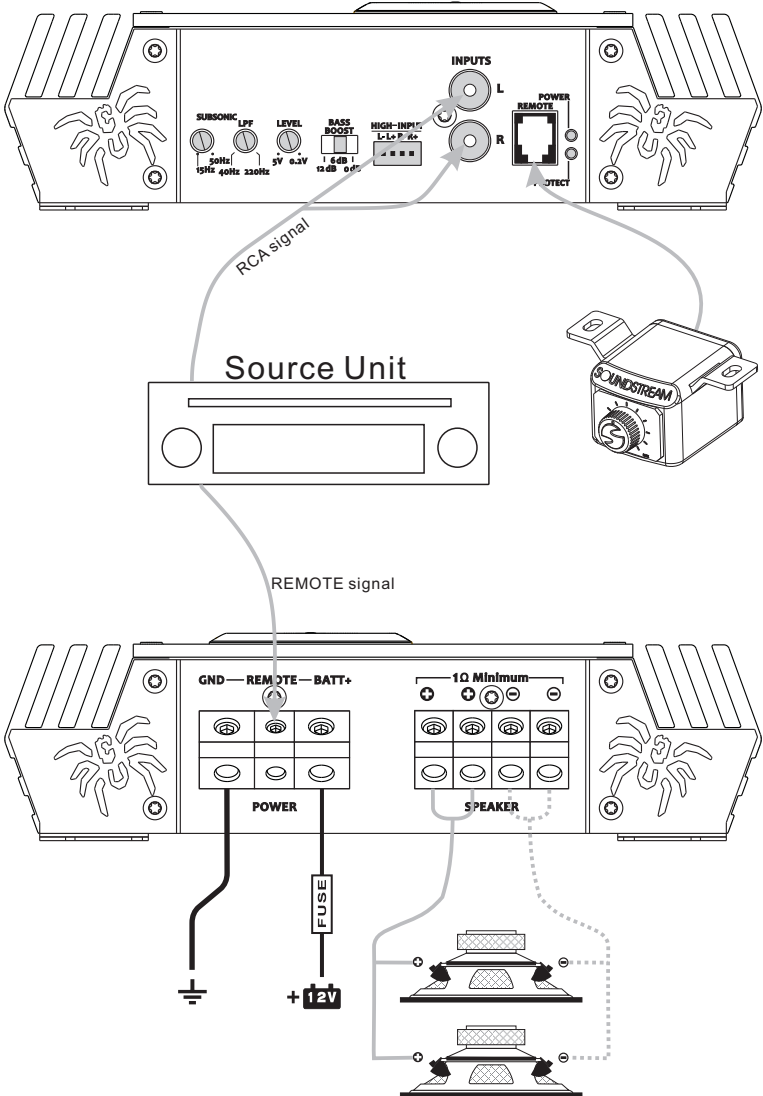

Fig 9. L2.290/L2.400 wiring
(2-channel mode)

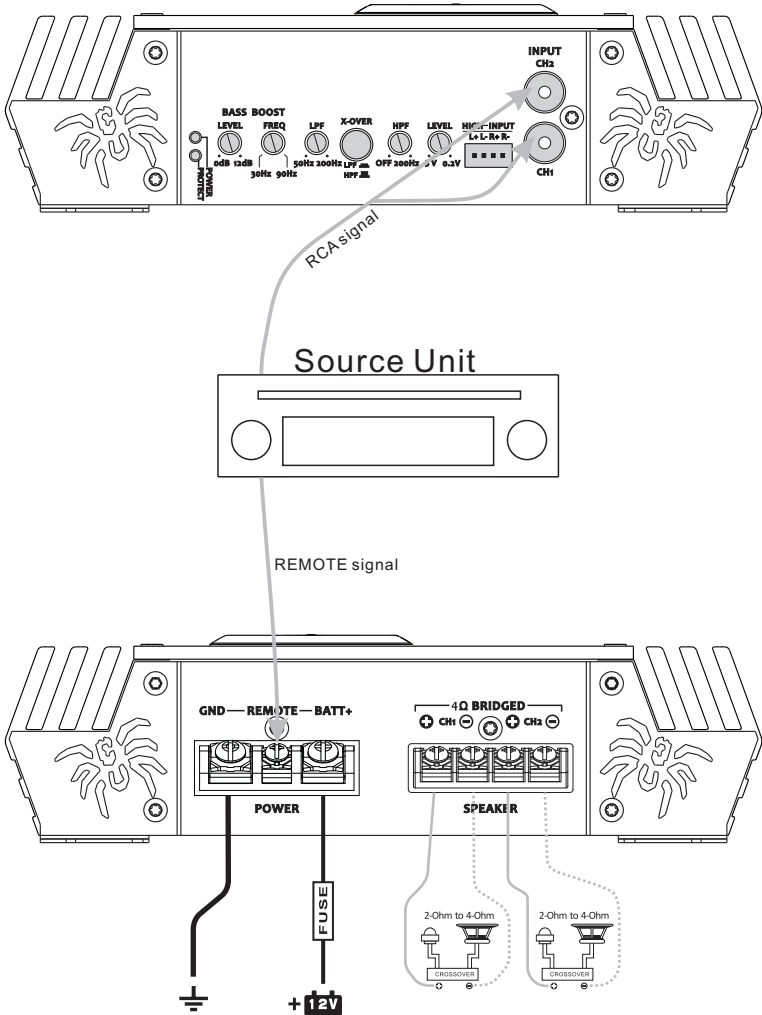

Fig 10. L2.290/L2.400 wiring
 (High level input & Bridged mode)

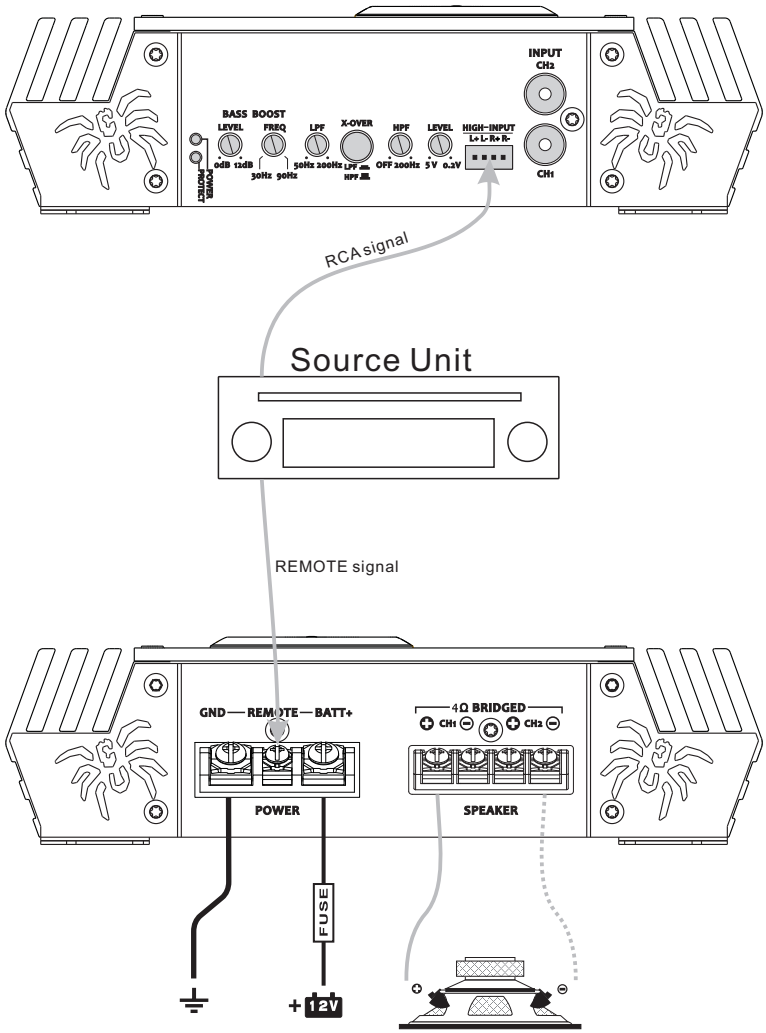

Fig 11. L4.480/L4.540 wiring
 (High level input & Bridged mode)

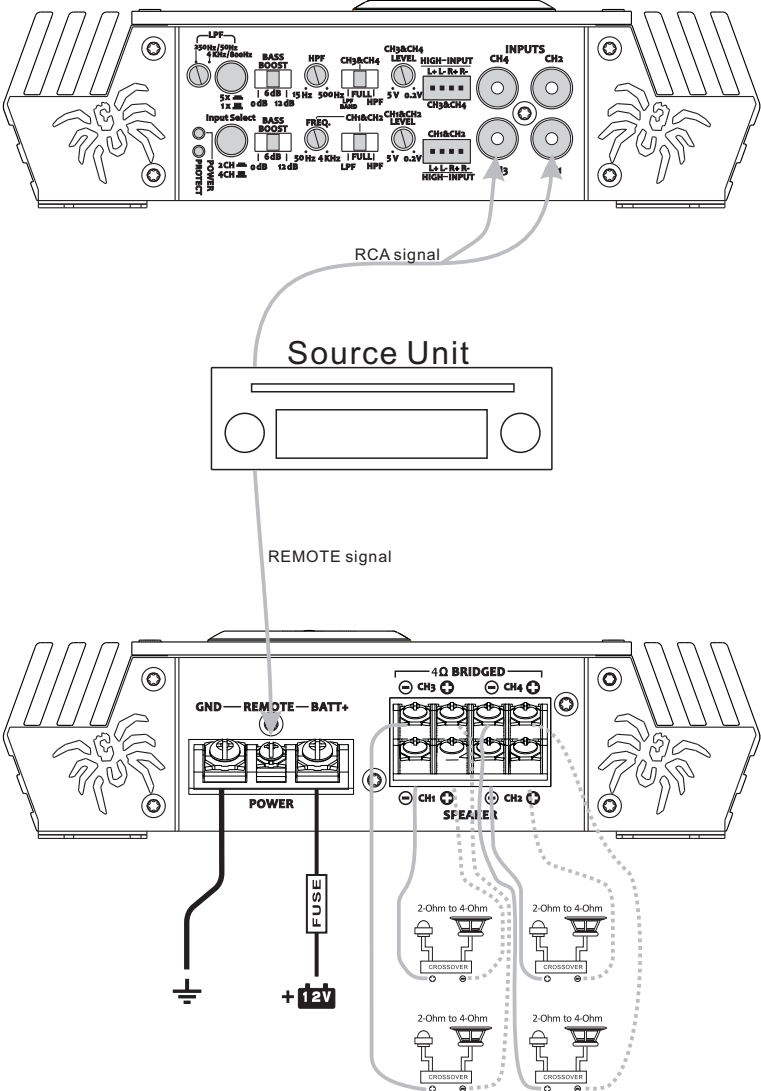

Fig 12. L5.850 wiring
(3-Channel mode)

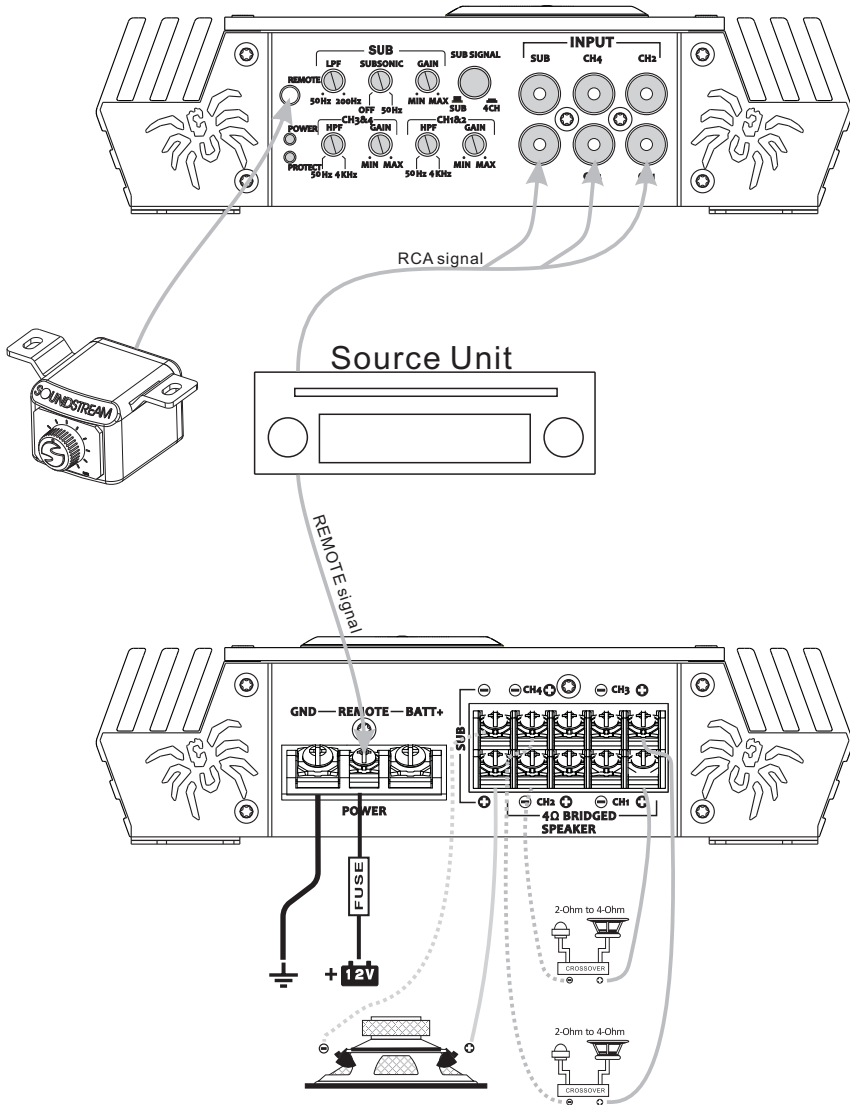
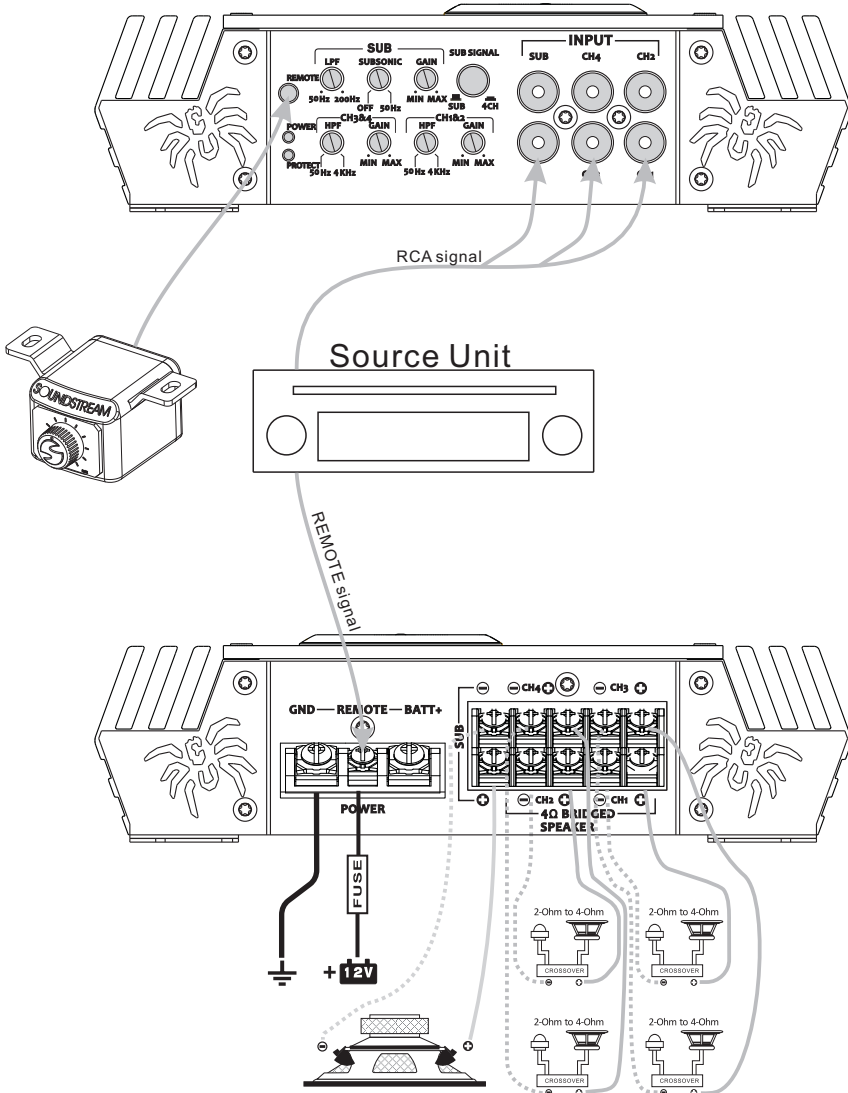

Fig 13. L5.850 wiring
(5-Channel mode)



TROUBLE SHOOTING

Symptom	Possible Remedy
Amplifier will not power up	<p>Check to make sure you have a good ground connection.</p> <p>Check that there is battery power on the (+)terminal .</p> <p>Check all fuses, replace if necessary .</p> <p>Make sure that the Protection LED is not illuminated.</p>
Protection LED Comes on	<p>Check for short circuits on speaker leads.</p> <p>Check the speaker load not beyond the minimum load.</p> <p>Remove speaker lead, and reset the amplifier. If the protection LED still Comes on, then the amplifier is faulty and needs servicing .</p>
No output	<p>Check that the RCA audio cables are plugged into the proper inputs.</p> <p>Check all speakers wiring.</p> <p>Check the headunit output and the amplifier level setting.</p>
Low output	<p>Reset the level Control.</p> <p>Check the Crossover Control settings.</p>
High hiss in The speakers	<p>Check the RCA cable is not shorted to power ground at amplifier side.</p> <p>Check the amplifier grounding.</p>
Distorted sound	<p>Check that the Input level control is set to match the signal level of the head unit. Always try to set the Input level as low as possible.</p> <p>Check that all crossover frequencies are properly set.</p> <p>Check for short circuits on the speaker leads.</p>
Amplifier gets Very hot	<p>Check that the minimum load impedance for the amplifier model is correct.</p> <p>Check that there is good air circulation around the amplifier. In some applications, It may be necessary to add an external cooling fan.</p>

SPECIFICATIONS

SPECIFICATION	L1. 600D	L1. 1100D	L1. 1600D	L1. 2100D	L2.290	L2.400	L4.480	L4.540	L5.850
	RMS power at 14.4V								
RMS, \leq 1% THD + N@1 ohms	550W x 1	1020W x 1	1560W x 1	2000W x 1	NA	NA	NA	NA	NA
RMS, \leq 1% THD + N@2 ohms	385W x 1	710W x 1	980W x 1	1200W x 1	140W x 2	180W x 2	140W x 4	170W x 4	125W x 4 + 500W
RMS, \leq 1% THD + N@4 ohms	235W x 1	420W x 1	590W x 1	700W x 1	85W x 2	110W x 2	85W x 4	105W x 4	85W x 4 + 300W
Bridged 4Ohm Load	NA	NA	NA	NA	280W x 1	360W x 1	280W x 2	340W x 2	250W x 2 +300W
Features									
Input Level	0.2-5V	0.2-5V	0.2-5V	0.2-5V	0.2-5V	0.2-5V	0.2-5V	0.2-5V	0.2-5V
High Level Input	YES	YES	YES	YES	YES	YES	YES	YES	NA
Frequency Response	15Hz-220Hz	15Hz-220Hz	15Hz-220Hz	15Hz-220Hz	15Hz-25KHz	15Hz-25KHz	15Hz-25KHz	15Hz-25KHz	15Hz-25KHz
X-over Type	LPF/Subsonic	LPF/Subsonic	LPF/Subsonic	LPF/Subsonic	LPF/Full/HPF	LPF/Full/HPF	LPF/Full/HPF	LPF/Full/HPF	LPF/Full/HPF
LPF	40Hz - 220Hz	40Hz - 220Hz	40Hz - 220Hz	40Hz - 220Hz	50Hz - 200Hz	50Hz - 200Hz	Front 50Hz - 4kHz, Rear 50Hz - 800Hz or 250Hz - 4kHz	Front 50Hz - 4kHz, Rear 50Hz - 800Hz or 250Hz - 4kHz	50Hz - 200Hz
	15Hz-50Hz	15Hz-50Hz	15Hz-50Hz	15Hz-50Hz	15Hz - 200Hz	15Hz - 200Hz	Front 50Hz - 4kHz, Rear 15Hz - 500Hz	Front 50Hz - 4kHz, Rear 15Hz - 500Hz	50Hz - 4kHz
THD	<0.5%	<0.5%	<0.5%	<0.5%	<0.05%	<0.05%	<0.05%	<0.05%	<0.5%
Damping Factor	>100	>100	>100	>100	>100	>100	>100	>100	>100
S/N Ratio	>95dB	>95dB	>95dB	>95dB	>95dB	>95dB	>95dB	>95dB	>95dB
Minimum Protection	0.6OHM	0.6OHM	0.6OHM	0.6OHM	1.2OHM	1.2OHM	1.2OHM	1.2OHM	1.2OHM
Voltage Protection	<8.4V & >16V	<8.4V & >16V	<8.4V & >16V	<8.4V & >16V	<8.4V	<8.4V	<8.4V	<8.4V	<8.4V
Components & PCB	SMD Parts / Double-Sided FR-4 PCB								
Bass Remote	Yes								
DIMENSION									
Height	52mm/2.05"								
Width	209mm/8.23"								
Length	265mm/10.43"	340mm/13.39"	340mm/17.91"	471mm/18.54"	275mm/10.83"	285mm/11.22"	315mm/12.40"	285mm/11.22"	446mm/17.56"

